

SIO GLASS FITTINGS



FLOOR SPRING



PATCH FITTING



GLASS DOOR PULL HANDLES



SHOWER HINGES AND GLASS CONNECTORS

SIO VASUNDDHARA INTERNATIONAL PRIVATE LIMITED

PEOPLE | CUSTOMERS | GROWTH

K - 2/836, Vasant Kunj Road, Near Mata Chowk, Mahipalpur, New Delhi - 110 037, INDIA.
Ph: +91 11 2678 5169 / 4103 2065 • Email: contact@sio.co.in • Web: www.sio.co.in
For Distribution Inquiries: +91 99104 89457 • For Institutional Inquiries: +91 99589 98108

SIO FS Sleek (SC 60 and SC 100)

Technical Details

- About 100,000 cycles tested
- Maximum door width 1000 mm
- Maximum door weight 100 kgs
- Non hold open for pool gates
- Cement box size
 - Length - 275 mm
 - Width - 108 mm
 - Height - 40 mm
- Adjustment in cement box
 - Length - 12 mm
 - Width - 8 mm
 - Height - 8 mm

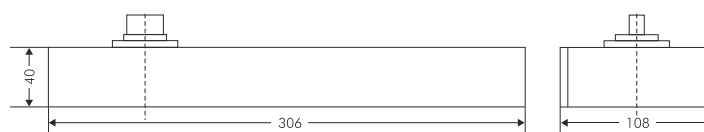
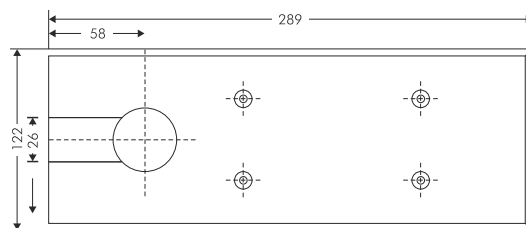

Available Finish

- Satin Stainless Steel
- Polish Stainless Steel

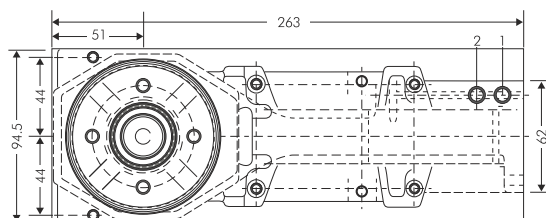

SIO FS Sleek HD (DC 120 and DC 150)

Technical Details

- About 100,000 cycles tested
- Maximum door width 1200 mm
- Maximum door weight 150 kgs
- Non hold open for pool gates
- Cement box size
 - Length - 306 mm
 - Width - 108 mm
 - Height - 40 mm
- Adjustment in cement box
 - Length - 10 mm
 - Width - 5 mm
 - Height - 5 mm

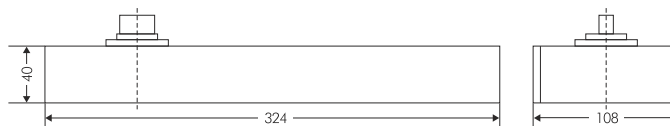
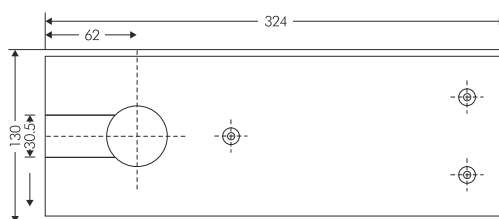

Available Finish

- Satin Stainless Steel
- Polish Stainless Steel

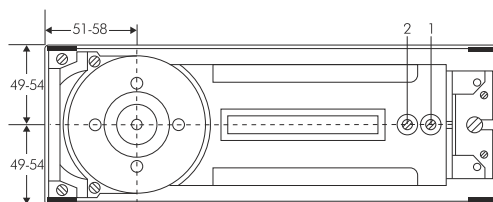

SIO PFC 60

Patch to secure the over panel and slide panel at the opening edge of the door.

Specifications

Open panel and Slide panel connector

- With SS 304 cover
- Cover secured with small "L" key
- Stainless Steel finish

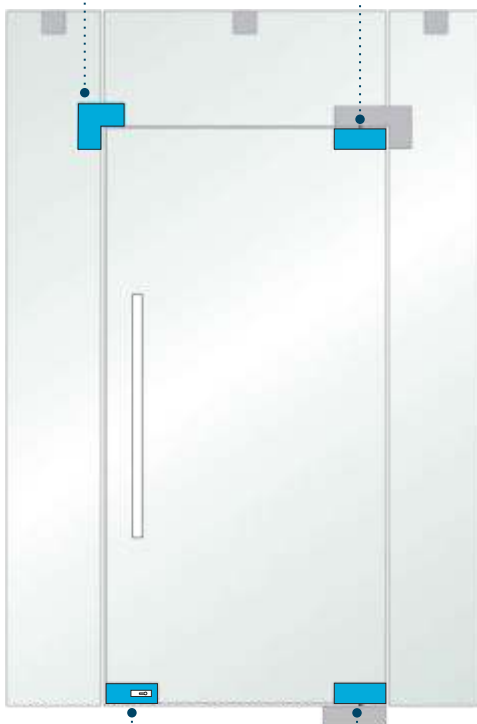
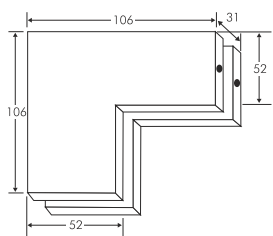

SIO PFC 20

Secured on to the door lead top to accept the Pivot of SIO PF-50 or PF-80.

Specifications

Top Patch

- With SS 304 cover
- Cover secured with small "L" key
- Adjustable pivot point 55/65 mm
- Stainless Steel finish

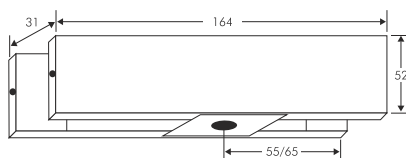

SIO PUS 10

To lock swing door on Floor/Ceiling

Specifications

With a euro profile cylinder and strike plate dead bolt projection of 15mm (single throw)

- Three high security computer keys
- With SS 304 cover
- Cover secured with small "L" key
- Stainless Steel finish

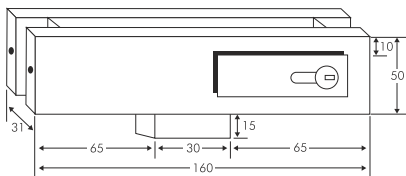

SIO PFC 10

Secured on to the bottom of the door leaf to accept the Spindle of SIO floor springs.

Specifications

Bottom Patch

- With SS 304 cover
- Cover secured with small "L" key
- Adjustable pivot point 55/65 mm
- Stainless Steel finish

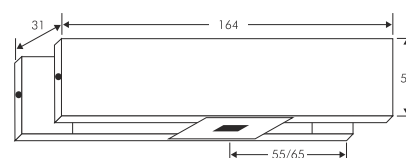

SIO Patch Fitting

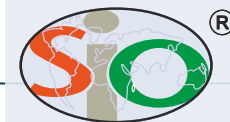

SIO PFC 040

Connects over panel and side panel with pivot.

Specifications

Over panel side panel connecting patch

- With SS 304 cover
- Cover secured with small "L" key
- Pivot pin of 15 mm diameter
- Adjustable pivot point 55/65 mm
- Stainless Steel finish

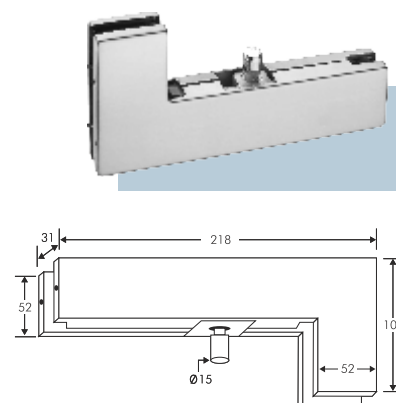

SIO PFC 030

Over panel with pivot.

Specifications

Over panel Patch

- With SS 304 cover
- Cover secured with small "L" key
- Adjustable pivot point 55/65 mm
- Stainless Steel finish

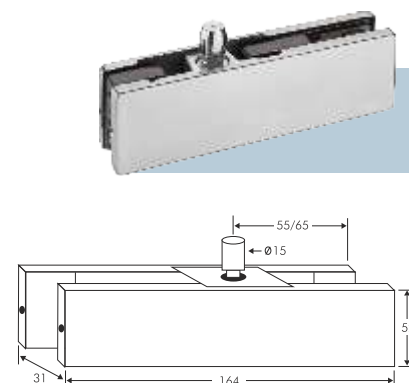

SIO PFC 100T

To secure glass with a Fixed structure (Ceiling, Floor or Wall)

Specifications

Glass clamping connector

- With SS 304 cover
- Cover secured with small "L" key
- Stainless Steel finish

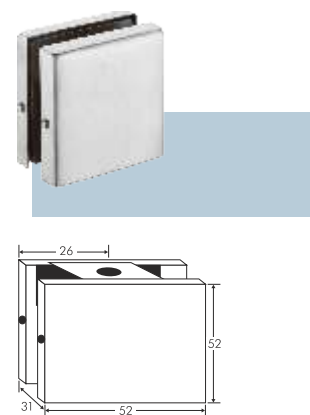

SIO PFC PS

Top pivot for Patch/Point fitting doors

Specifications

Stainless Steel Pivot

- Wear resistant SS 304 pivot pin
- Top pivot with 15 mm dia pin
- Pivot held in overhead structure
- Stainless Steel finish

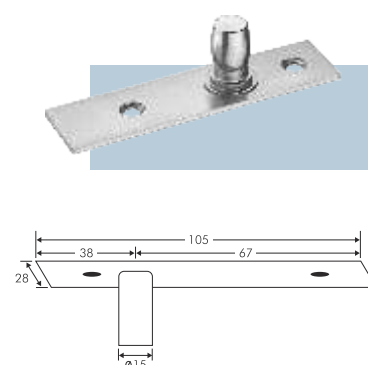

* SS in Matt Finish. Other Finishes available on request.

SIO Shower Hinges & Glass Connectors



SIO SH-1

Glass Door Hinge Connected to Wall

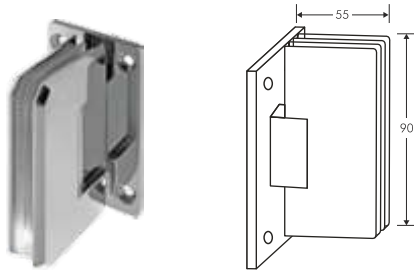

SIO SH-2

For connecting a Glass Door with a Fixed Glass at 180°

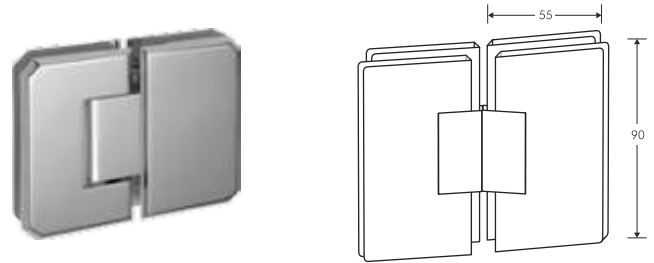

SIO SH-3

For connecting a Glass Door with a Fixed Glass at 135°

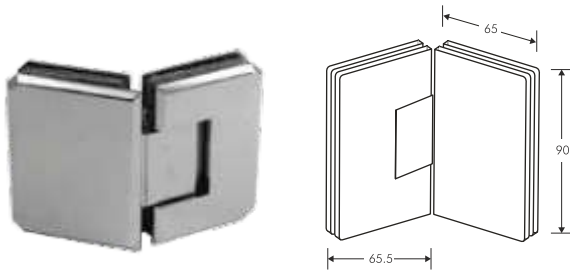

SIO SH-4

For connecting a Glass Door with a Fixed Glass at 90°

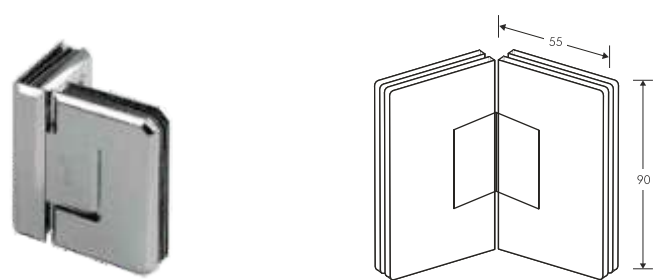

SIO SH-5

To Hold the Fixed Glass with Wall

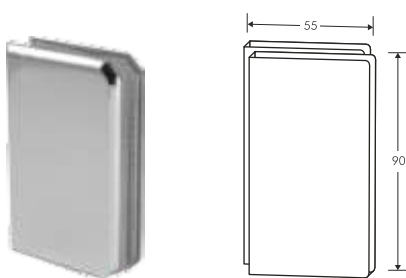

SIO GC-WGF

Wall to Glass Fixed Connector
Suitable for 10-12mm Glass Thickness

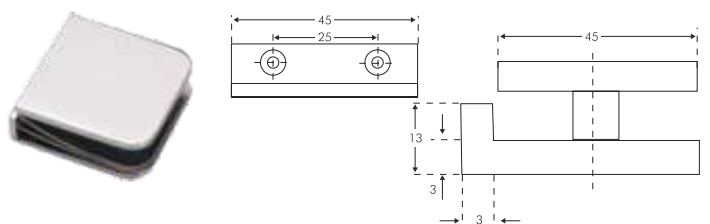

SIO GC-GG 135°

Glass to Glass 135°
Suitable for 10-12mm Glass Thickness

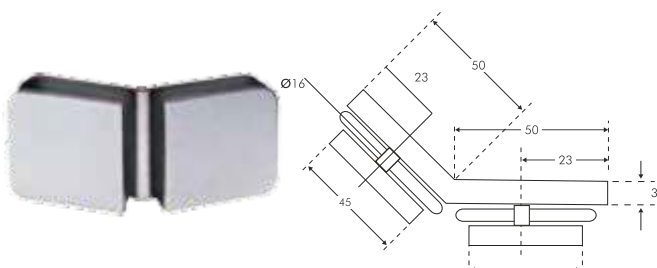

SIO GC-GG 90°

Glass to Glass 90°
Suitable for 10-12mm Glass Thickness

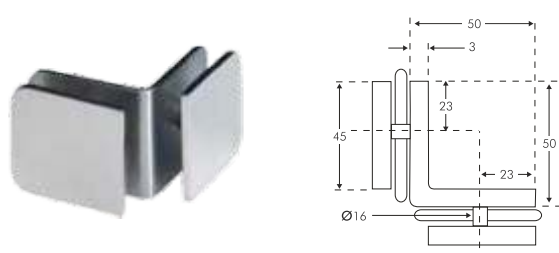

SIO GC-WG 90°

Wall to Glass 90°
Suitable for 10-12mm Glass Thickness

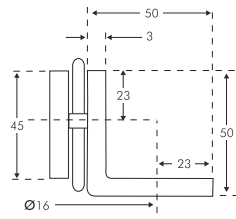

SIO GC-GG 180°

Glass to Glass 180°
Suitable for 10-12mm Glass Thickness

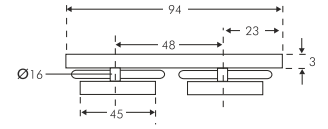

SIO Glass Door Pull Handles

SIO SS PH H

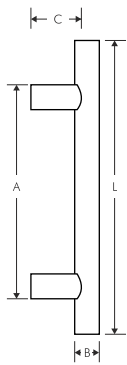

Specifications

L	A	B
400	300	22
450	350	25
600	350	32

SIO SS PH D

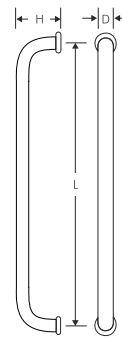

Specifications

L	D
305	25
350	25
305	32
350	32
450	38

SIO SS PH C

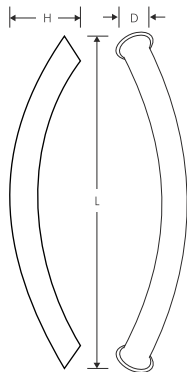

Specifications

L	D
200	25
305	25
305	32
350	32

SIO SS TB



Specifications

L	D
450	19
600	22

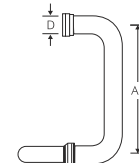
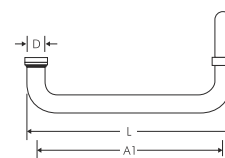

* Material - SS 304. Other materials available on request. Customized orders are accepted. Turnkey projects undertaken. Specifications subject to change.



www.sio.co.in

SIO VASUNDDHARA INTERNATIONAL PVT. LTD.

Founded with the vision to work with fairness, honesty and courtesy towards all internal and external stakeholders to achieve the company's objectives, Sio Vasunddhara International has serviced such prestigious names as ABB, DLF, LnT, PVR, TAJ hotels and resorts, Unitech, Fortis, Airtel, bata, The Oberoi, HP, Raheja developers and many others.